

MAURER SHARK[®]

Short-Stroke Hysteretic Damper

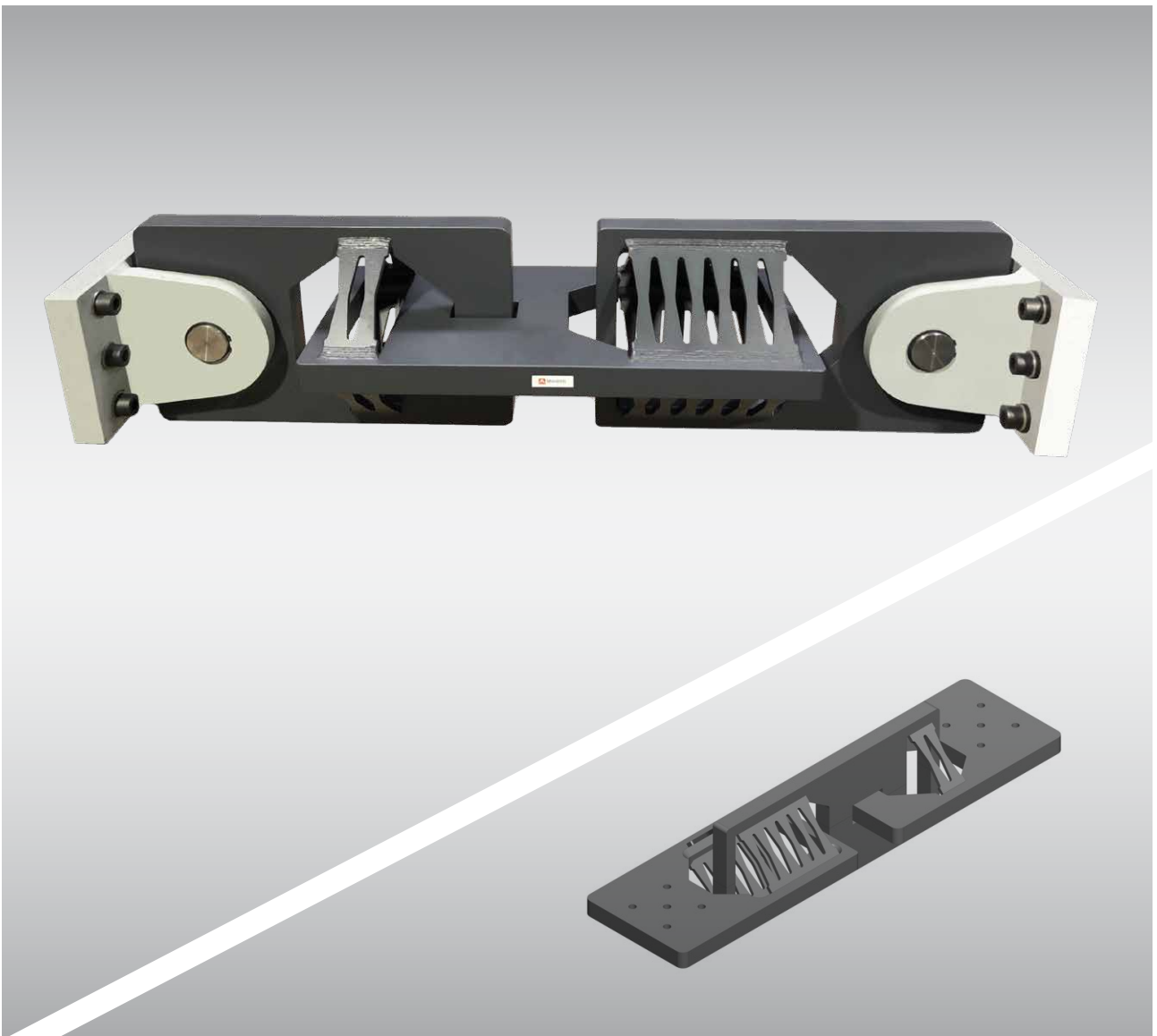

MAURER SHARK[®]

Implementation in buildings' bracing systems

The SHARK® Damper is an innovative energy dissipation device capable of providing absolute structural safety and avoiding potential earthquake induced damages. The device is made of steel and, thanks to its innovative patented design, represents a simple but extremely efficient energy absorber. Under wind and thermal loads it operates within its elastic regime and reacts like a stiff spring providing structural stability. During the earthquake event, the SHARK® dissipates seismic energy through plastic deformation of special shaped hysteretic lamellas. Based on the customer's design targets, the damper can be provided in two configurations (SHARK® and SHARK®-Adaptive) which have different performance characteristics. Both configurations are intended to be incorporated into a buildings' reinforced concrete or steel frame bracing system in order to limit the inter-story drift, while preventing potential structural damage induced by the seismic action. In addition the SHARK®-Adaptive minimizes the accelerations at each level to ensure better protection of sensitive non-structural components.

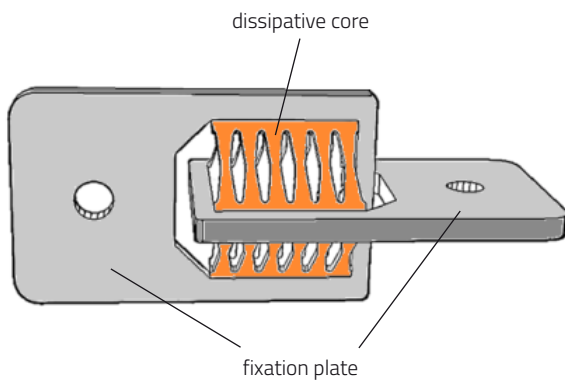

Single dissipative core (SHARK®)

The SHARK® damper operates as a highly effective bilinear hysteretic device. The energy dissipation is produced by a series of hysteretic lamellas oriented on the four faces of the hollow section of the dissipative core. The damper is designed for severe ultimate limit state (ULS) earthquakes and offers a reliable and stable response. The special shape of the lamellas allows the damper to withstand up to 3-4 MCE events without any failure. Even after multiple seismic excitations the parallel redundant arrangement of the lamellas offers an extreme high level of safety since after a theoretical failure of one specific lamella the remaining provide proportional resisting force and damping. Like other traditional bilinear dampers, during minor serviceability limit state (SLS) events, the SHARK® mostly operates in its elastic range and reacts as a stiff restrainer without reducing the earthquake input. This performance characteristic can lead to increased peak floor accelerations that can be detrimental for the non-structural content (e.g. elevators, electric panels) of the building. This issue can be effectively addressed through utilization of the SHARK®-Adaptive configuration.

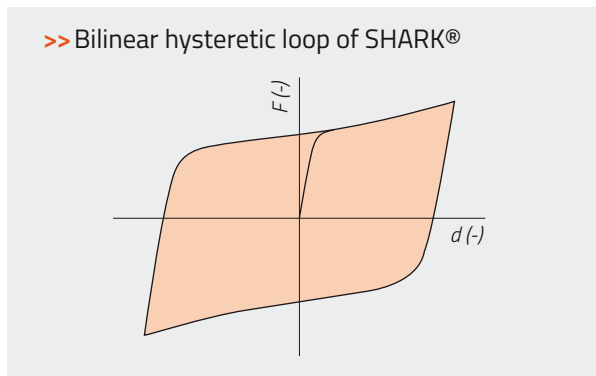

>> LEGEND:  Hysteretic damper

Two dissipative cores for adaptive behaviour (SHARK®-Adaptive)

The SHARK®-Adaptive damper features a unique “two stage” hysteretic loop that allows for adjustment of effective stiffness and damping based on the intensity of the earthquake. For weak but frequent design earthquakes the device is quite flexible and offers minor, but adequate, energy dissipation. This behaviour minimizes peak floor accelerations for effective protection of sensitive non-structural components of the building (e.g. elevators, electric panels, false ceilings). During strong MCE events the device suddenly stiffens achieving a much higher damping force with the aim to limit the maximum structural drift ratio. The two dissipative cores are arranged in series and are linked with a “gap-connector plate”. For small displacements ($|d| \leq d_{GAP}$), the minor dissipative core (green; regime 1) is activated first in its elastic and then its plastic regime to increase the structural damping. During these small displacements, the major core (orange) remains in the elastic range. For bigger displacement amplitudes ($|d| > d_{GAP}$), the major hysteretic core (regime 2) becomes engaged and offers a higher effective stiffness and damping.

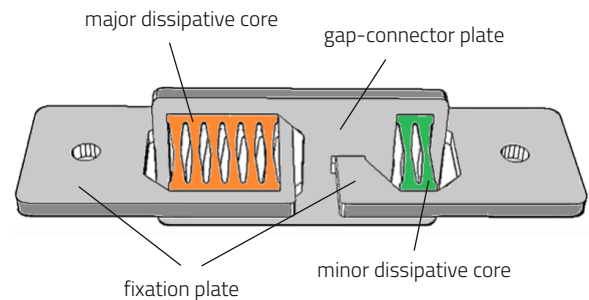

>> Two-level hysteretic loop of SHARK®-Adaptive

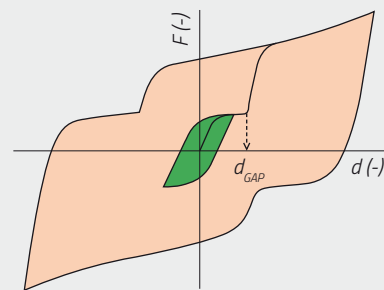

Key benefits of SHARK®

- No regular maintenance required and high reliability due to simplicity of utilizing only one material
- Service life similar to building structural system
- Stable response to 3-4 MCE earthquake events without any failure
- Redundant safety level thanks to the parallel arrangement of the hysteretic lamellas
- Simple bilinear model suitable for analysis
- Compact size
- Easy visual inspection and replacement if necessary after fire or other unforeseen events
- High fatigue strength against wind and other service loads
- Design according to the European Standard EN15129 or other Standards on request

Additional benefits of SHARK®-Adaptive

- Customized and optimized behaviour provides effective protection of non-structural components and technological content of the building because of the flexible damper response (minimization of peak floor accelerations) under weak but frequent SLS earthquakes. This beneficial performance is essential for high technology buildings (e.g. hospitals, police stations, fire stations, data centres, important commercial structures or emergency management centres) that are required to remain fully operational in the emergency response after an earthquake. On the contrary, during severe MCE events, the SHARK®-Adaptive offers greater stiffness and damping level to prevent structural damages – minimization of structural drift ratio.

Sizes and performance data

>> Type – SHARK®

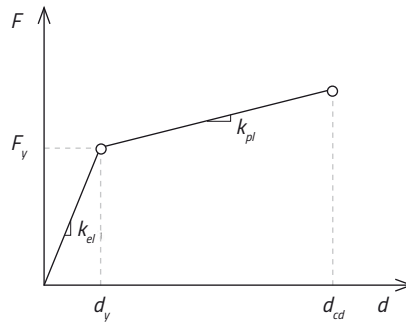
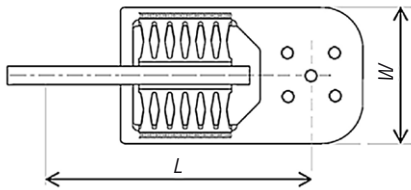

| | | | | | | | | | |
|--------------------------------------|-----------|---------|-------|-------|-------|-------|-------|-------|-------|
| MCE max. force | F_{MCE} | [kN] | 350 | 700 | 1000 | 1400 | 1700 | 2100 | 2400 |
| Yielding force | F_y | [kN] | 220 | 410 | 615 | 820 | 1020 | 1230 | 1430 |
| Elastic stiffness | K_{el} | [kN/mm] | 100 | 165 | 245 | 325 | 410 | 490 | 570 |
| Plastic stiffness | K_{pl} | [kN/mm] | 4 | 6 | 9 | 12 | 15 | 18 | 21 |
| SLS design displacement | d_{SLS} | [±mm] | ≤ 1.0 | ≤ 1.0 | ≤ 1.0 | ≤ 1.0 | ≤ 1.0 | ≤ 1.0 | ≤ 1.0 |
| MCE seismic design displacement | d_{MCE} | [±mm] | 35 | 50 | 50 | 50 | 50 | 50 | 50 |
| Displacement capacity | d_{cd} | [±mm] | 50 | 70 | 70 | 70 | 70 | 70 | 70 |
| Length pin to pin | L | [mm] | 700 | 800 | 900 | 1000 | 1100 | 1200 | 1300 |
| Max width in both lateral directions | W | [mm] | 560 | 580 | 600 | 620 | 640 | 660 | 680 |

>> Type – SHARK®-Adaptive

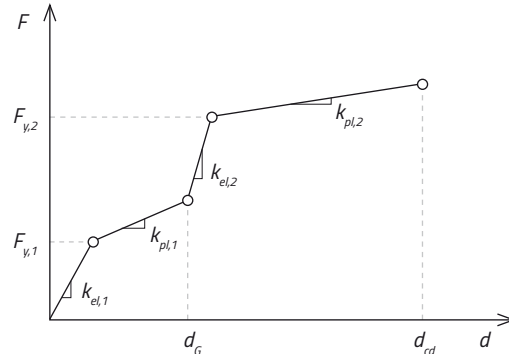
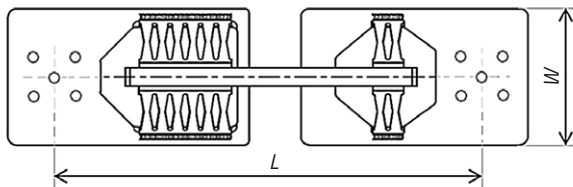

| | | | | | | | | | |
|--------------------------------------|------------|---------|-------|-------|-------|-------|-------|-------|-------|
| MCE max. force | F_{MCE} | [kN] | 350 | 600 | 1300 | 1650 | 1950 | 2300 | 2600 |
| DBE yielding force 1 | $F_{y,1}$ | [kN] | 105 | 190 | 320 | 410 | 410 | 615 | 615 |
| DBE Elastic stiffness 1 | $k_{el,1}$ | [kN/mm] | 30 | 60 | 80 | 115 | 125 | 170 | 180 |
| DBE Plastic stiffness 1 | $K_{pl,1}$ | [kN/mm] | 1 | 3 | 4 | 6 | 6 | 9 | 9 |
| MCE yielding force 2 | $F_{y,2}$ | [kN] | 250 | 440 | 815 | 1020 | 1230 | 1430 | 1635 |
| MCE elastic stiffness 2 | $k_{el,2}$ | [kN/mm] | 120 | 205 | 325 | 410 | 490 | 570 | 655 |
| MCE plastic stiffness 2 | $K_{pl,2}$ | [kN/mm] | 4 | 7 | 12 | 15 | 18 | 21 | 24 |
| SLS design displacement | d_{SLS} | [±mm] | ≤ 1.0 | ≤ 1.0 | ≤ 1.0 | ≤ 1.0 | ≤ 1.0 | ≤ 1.0 | ≤ 1.0 |
| DBE seismic gap displacement | d_G | [±mm] | ≤ 15 | ≤ 20 | ≤ 45 | ≤ 45 | ≤ 45 | ≤ 45 | ≤ 45 |
| MCE seismic design displacement | d_{MCE} | [±mm] | 40 | 45 | 90 | 90 | 90 | 90 | 90 |
| Displacement capacity | d_{cd} | [±mm] | 55 | 60 | 120 | 120 | 120 | 120 | 120 |
| Length pin to pin | L | [mm] | 1700 | 1900 | 2100 | 2200 | 2300 | 2400 | 2500 |
| Max width in both lateral directions | W | [mm] | 560 | 580 | 620 | 640 | 660 | 680 | 700 |

Performance testing

Both SHARK® and SHARK®-Adaptive were successfully tested according to the European Standard EN15129 at Bundeswehr University of Munich and at EUCENTRE Laboratory, in Pavia (Italy). CE marking is possible on request.



SHARK® at max tension position



SHARK®-Adaptive at max compression displacement



SHARK®-Adaptive at max tension displacement

>> SHARK® experimental hysteric loops

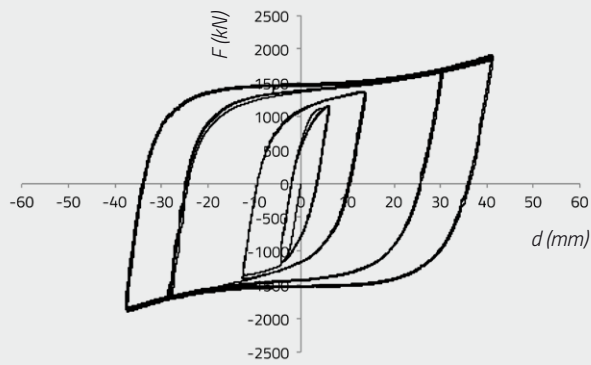

>> SHARK®-Adaptive experimental hysteric loops

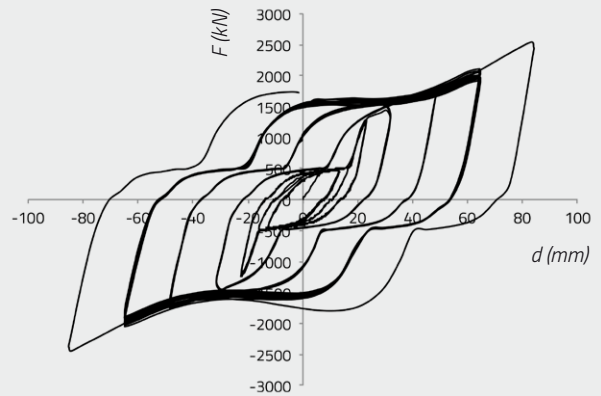

Device optimization

The design of both SHARK® and SHARK®-Adaptive has been developed and optimized with non-linear FEM analyses and can be customized when necessary to meet customer's special requirements.

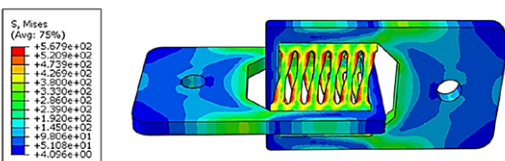

FE-model of SHARK®

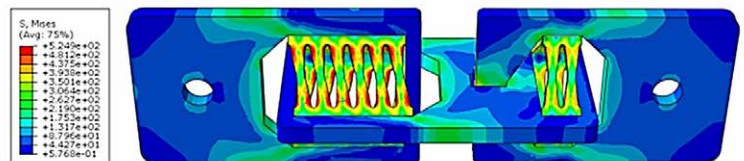

FE-model of SHARK®-Adaptive

Possible installation layouts

Two typical samples of an installation layout are recommended. On request MAURER can also provide the bracing system steel components. The connection to the construction can be designed according to the project, for example as screwed or welded connection.

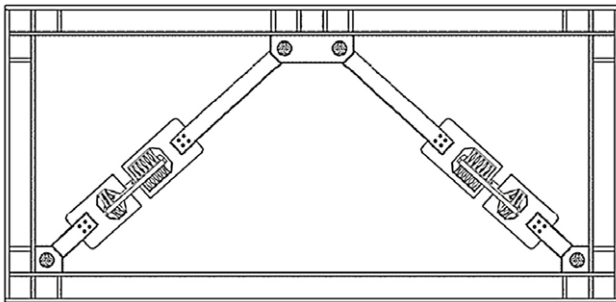

Installation layout 1

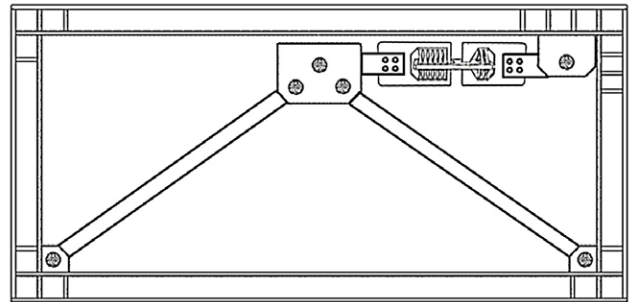

Installation layout 2

Device optimization

The design of both SHARK® and SHARK®-Adaptive has been developed and optimized with non-linear FEM analyses and can be customized when necessary to meet customer's special requirements.

|  | MAURER SHARK® | | Other types | |
|---|---------------|-----------------|-------------|------|
| | SHARK® | SHARK®-Adaptive | BRB | FVD |
| Protection of the structure (during severe ULS earthquake) | ++++ | ++++ | ++++ | ++++ |
| Protection of non-structural components (during minor SLS earthquake) | ++ | ++++ | + | ++++ |
| Long-term reliability (against wear and fatigue problems) | ++++ | ++++ | ++++ | ++ |
| Redundant safety level | ++++ | ++++ | + | ++ |
| Easy visual inspection | ++++ | ++++ | + | ++ |
| Easy to replace | ++++ | ++++ | + | ++++ |
| Low cost | ++++ | +++ | ++++ | + |





Ranking criteria: ++++ very good +++ acceptable ++ poor + very poor

Optional MAURER MONITORING SYSTEM (MMS-Basic)

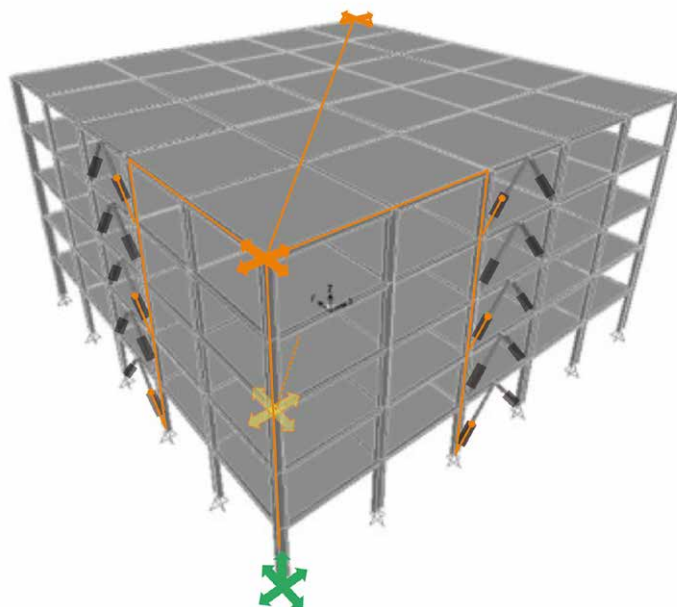
The SHARK® system and each floor slab can be instrumented with the standardized MAURER Monitoring System (MMS-Basic). The earthquake event-triggered recorded data will be automatically analysed to check if both the structural acceleration and inter-storey drift limits have been exceeded as well as the displacement capacity of the SHARK® system. This information is valuable to do a preliminary assessment of the structural integrity of the building and verify its suitability to be immediately operational. The MMS-Basic1 provides a limited amount of sensors (max 16 channels) and is hence suitable for low to mid rise (up to 12 floors) buildings. The MMS-Basic2 (max 32 channels) is equipped with additional sensors for intermediate storey levels and is conceived for high-rise buildings or complex structures.

| DATA RECORDING AND POST-PROCESSING | |
|---|--|
| Peak Ground Acceleration (PGA) & frequency content | → comparison with acceleration response spectrum at both MCE and DBE design levels |
| Peak Floor Accelerations (PFA) | → strong events (PGA \cong MCE design level): comparison with expected acceleration levels (structural protection target) → weak events (PGA \leq DBE design level): comparison with capacity of acceleration-sensitive non-structural components (immediate operation target) |
| Maximum damper displacement | → strong events (PGA \cong MCE design level): (a) comparison with damper displacement capacity; (b) calculation of maximum inter-storey drift and comparison with flexural capacity of columns (structural protection target) → weak events (PGA \leq DBE design level): calculation of maximum inter-storey drift and comparison with capacity of drift-sensitive non-structural components (immediate operation target) → service conditions (wind and thermal loads): cumulative displacement for fatigue analysis |



| | |
|--|--|
| MMS-Basic1 (max 16 channels) - minimal layout | |
|  | 1 x three-axis accelerometer at ground level |
|  | 2 x two-axis accelerometer at roof level |
|  | 6 x displ. transducer for SHARK dampers |
| MMS-Basic2 (max 32 channels) - additional sensors | |
|  | 4 x 2-axis accelerometer at mid floor levels |
|  | 8 x displ. transducer for SHARK dampers |

Quality control

- EN ISO 9001 and EN ISO 14001
- Design, testing and quality management according to EN15129 „Anti-Seismic Devices“ and other standards are possible
- CE marking (according to EN15129) on demand
- Testing at independent university
- Quality audits together with client on demand

